

HYDRANTULA

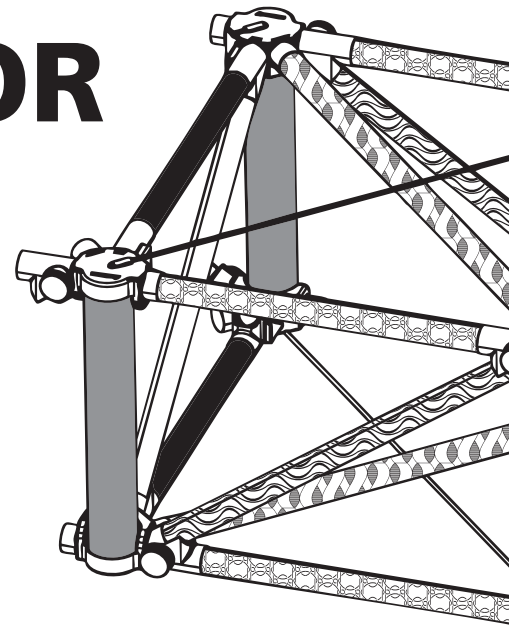

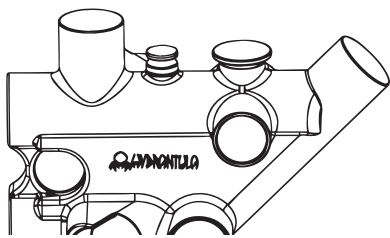

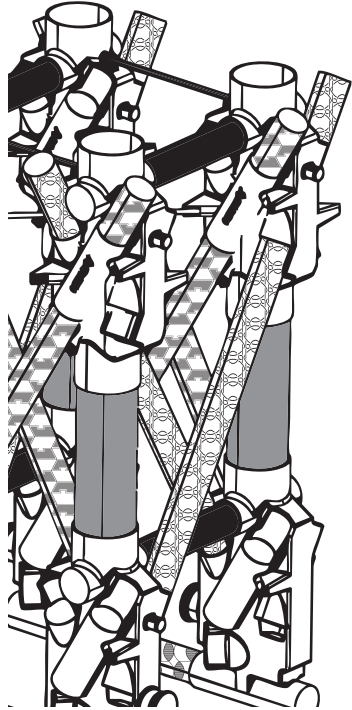
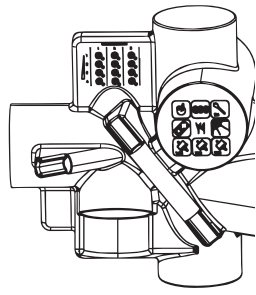

HYDRANTULA BEAM LENGTH CALCULATOR

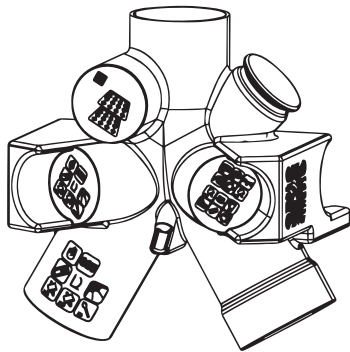
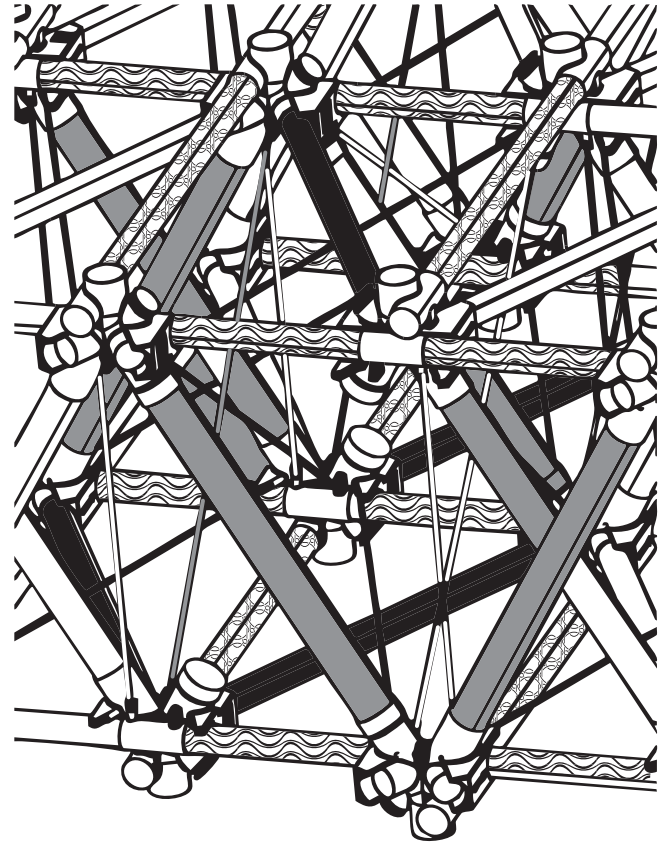
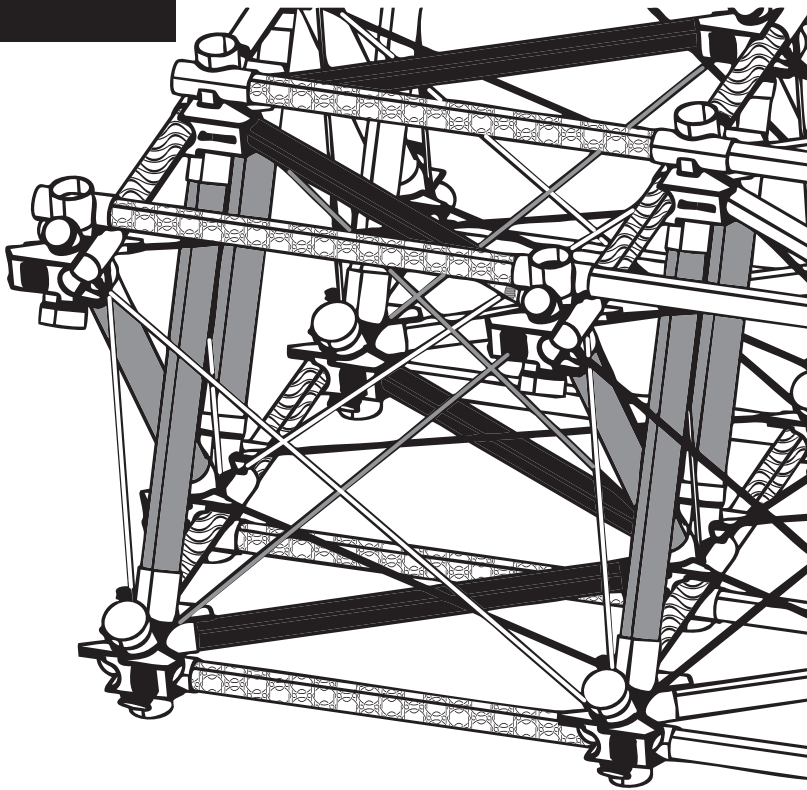

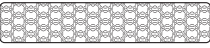
H1

L2

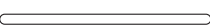

- ① 
- ② 
- ③ 
- ④ 
- ⑤ 
- ⑥ 
- ⑦ 

	Ø	F, mm	K	Type
①				
②				
③				
④				
⑤				
⑥				
⑦				

H1

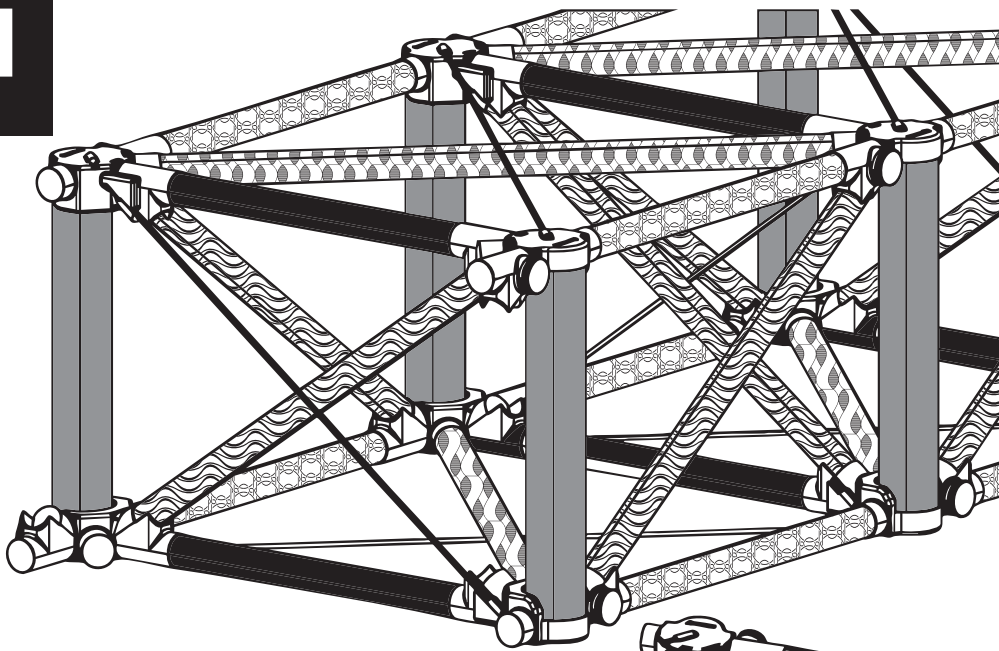

C5

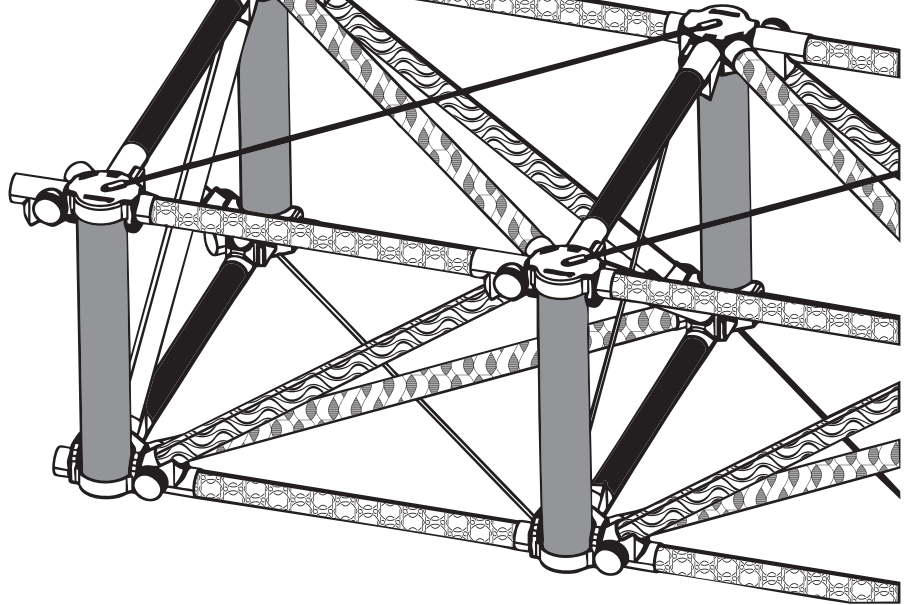
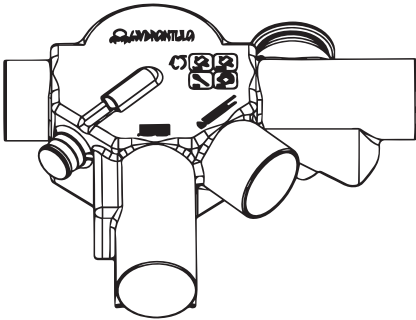

- 1
- 2
- 3
- 4
- 5
- 6
- 7

	Ø	F, mm	K	Type
1				
2				
3				
4				
5				
6				
7				

H2

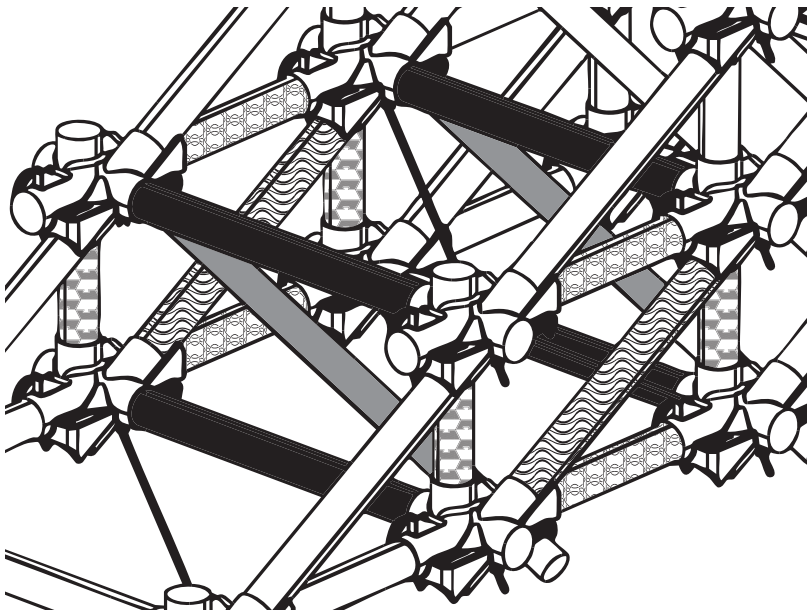

Y4

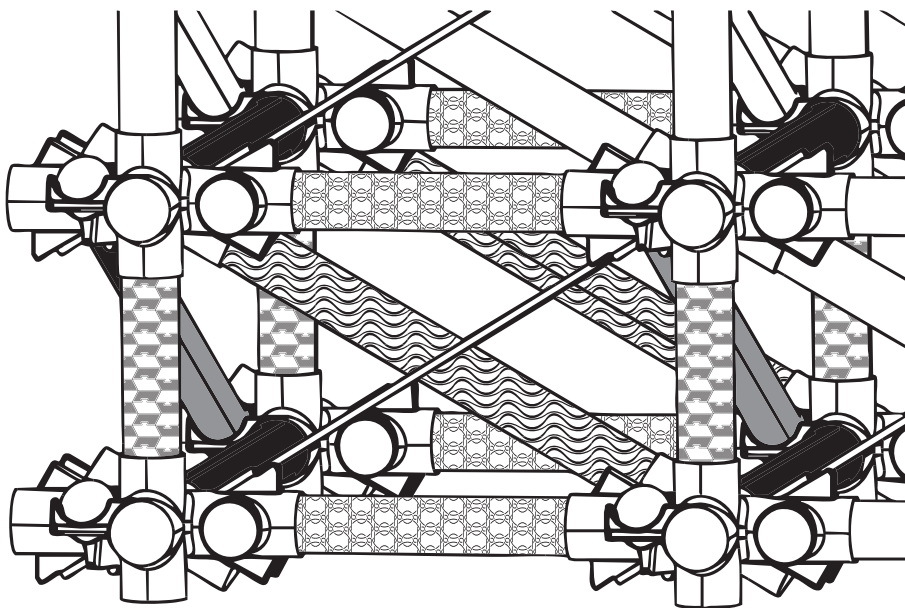
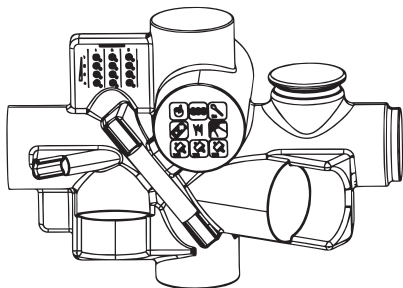





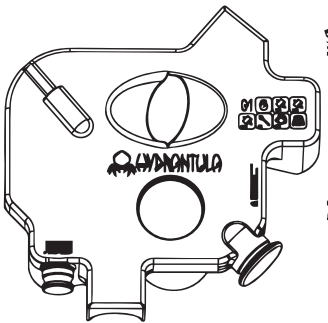
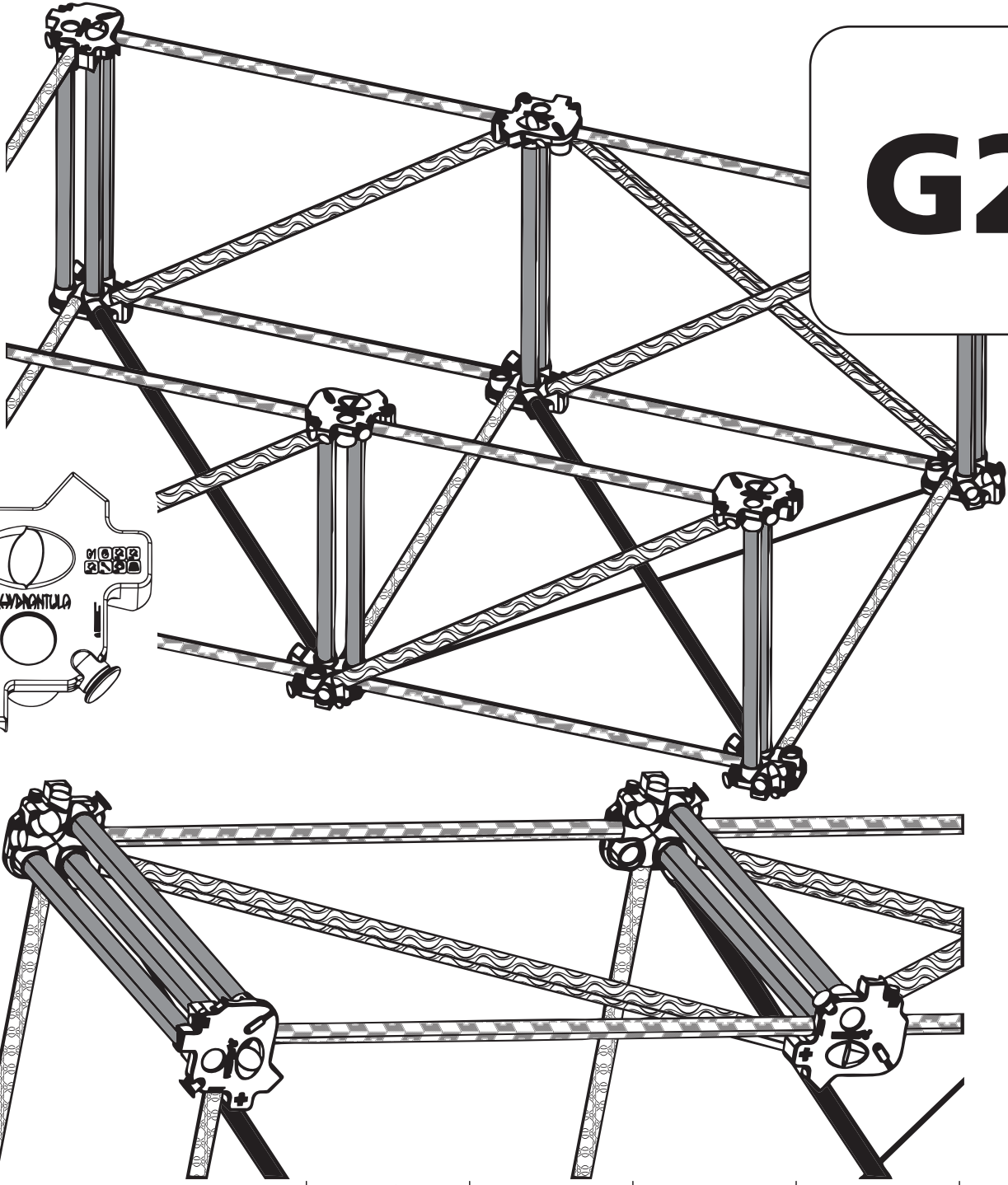

- 1
- 2
- 3
- 4
- 5
- 6
- 7
- 8

	Ø	F, mm	K	Type
1				
2				
3				
4				
5				
6				
7				
8				

H3

G2



- 1 
- 2 
- 3 
- 4 
- 5 
- 6 

	Ø	F, mm	K	Type
1				
2				
3				
4				
5				
6				

H3

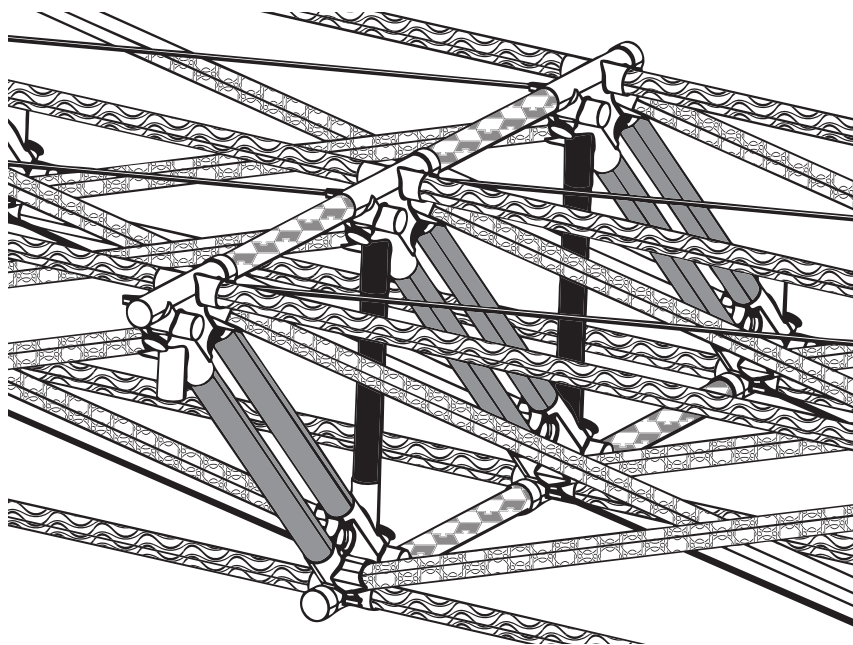

U45

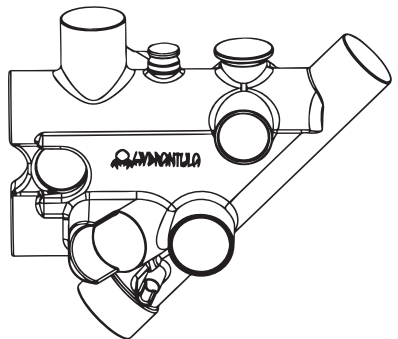
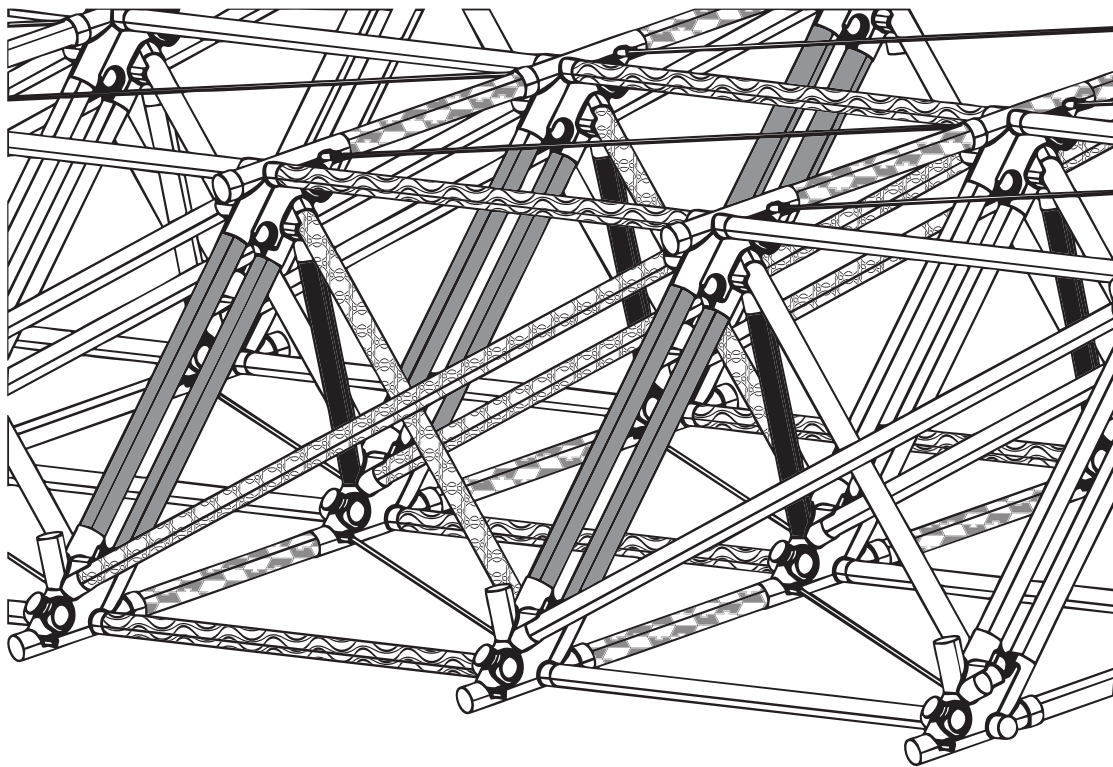





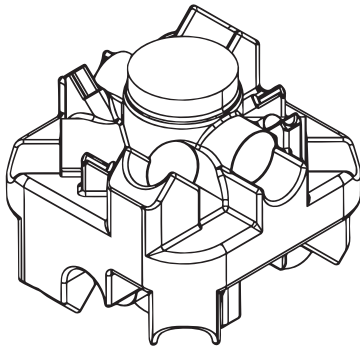
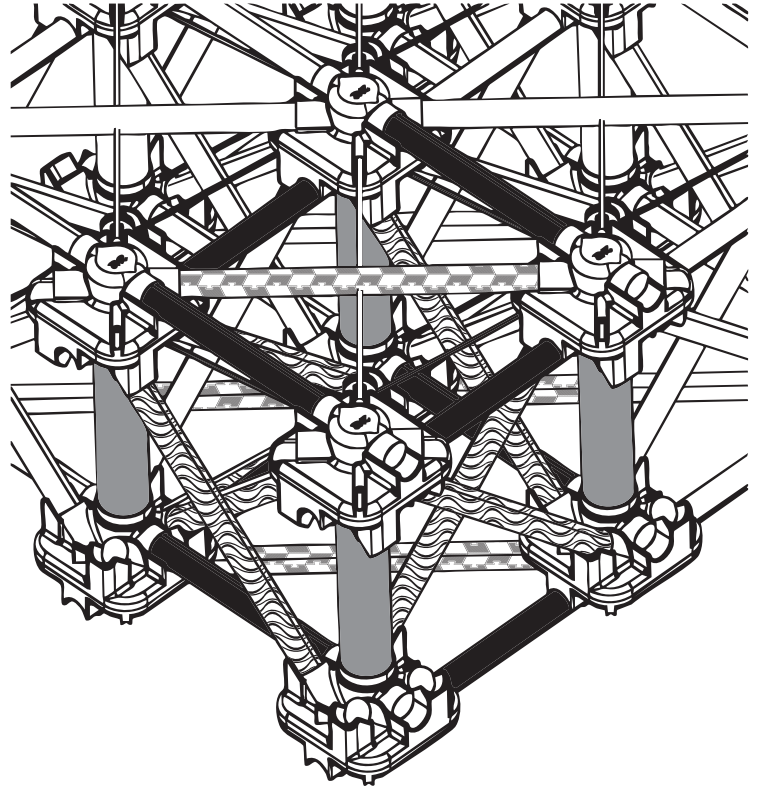
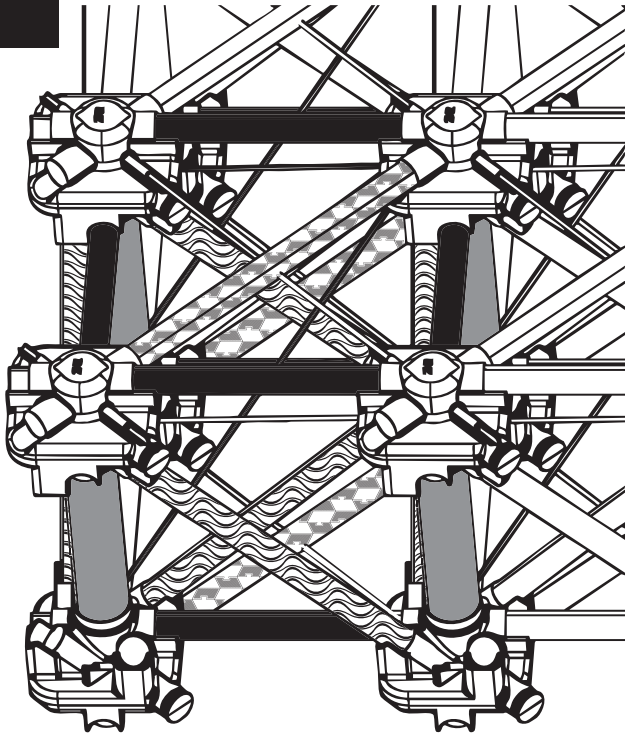

- 1
- 2
- 3
- 4
- 5
- 6

	Ø	F, mm	K	Type
1				
2				
3				
4				
5				
6				

H4

A18



- 1 
- 2 
- 3 
- 4 
- 5 
- 6 

	\emptyset	F, mm	K	Type
1				
2				
3				
4				
5				
6				

H5

B61

B62

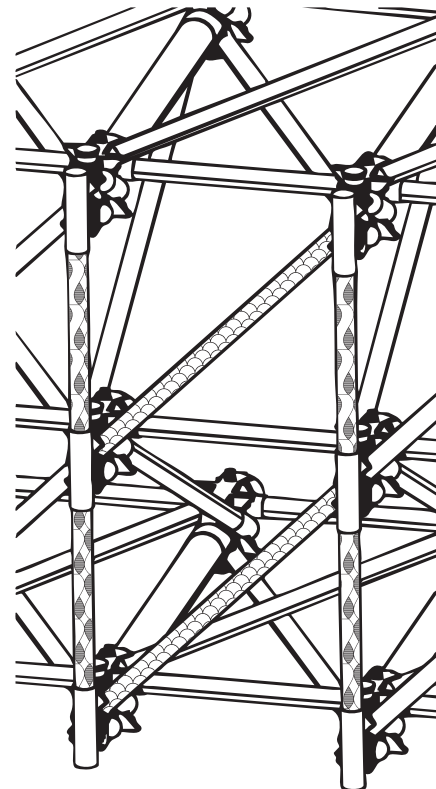
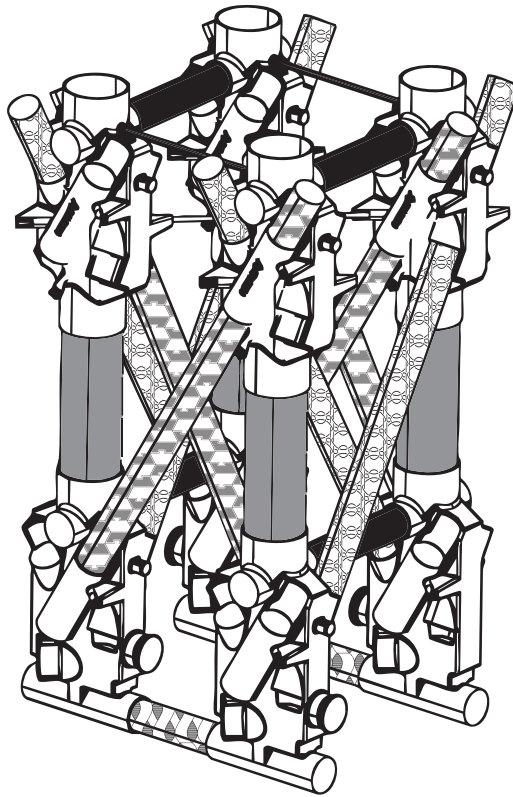
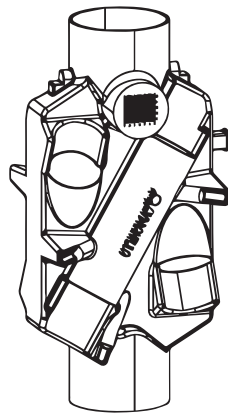
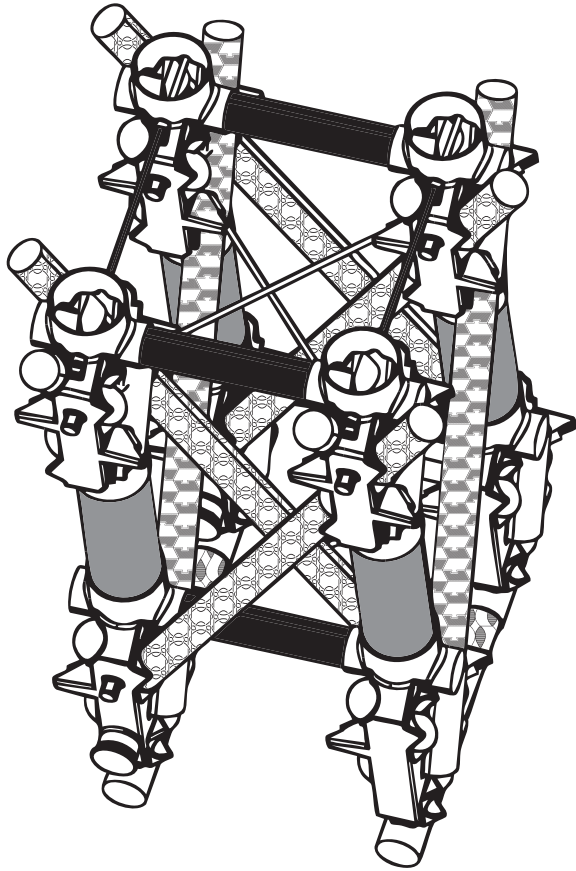

- 1
- 2
- 3
- 4
- 5
- 6
- 7
- 8
- 9

	Ø	F, mm	K	Type
1				
2				
3				
4				
5				
6				
7				
8				
9				